

## MEASUREMENTS

A:

B:

B1:

B2:

C:

C1:

E:

G:

M:

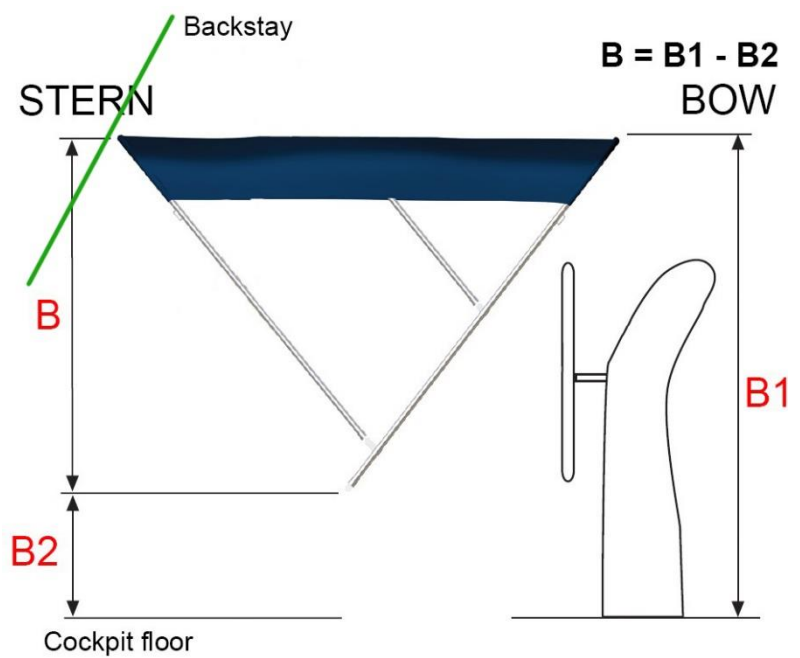
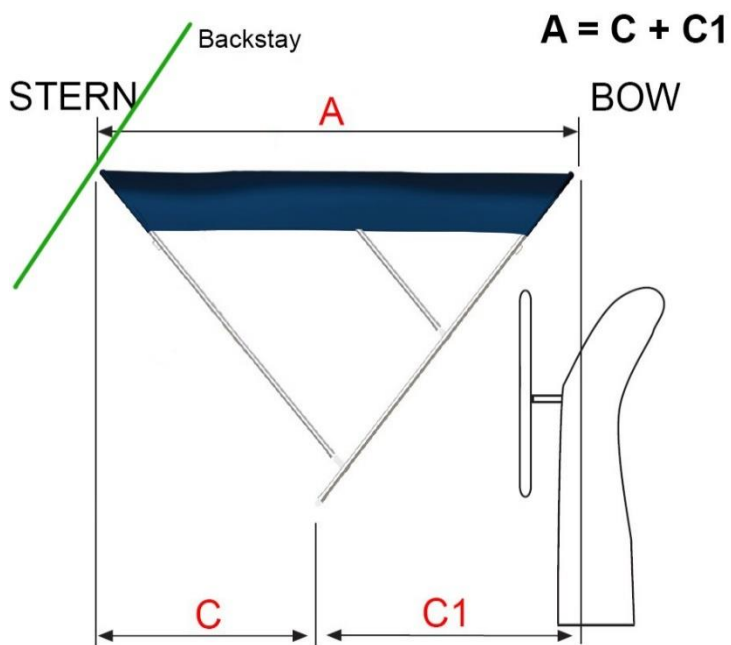
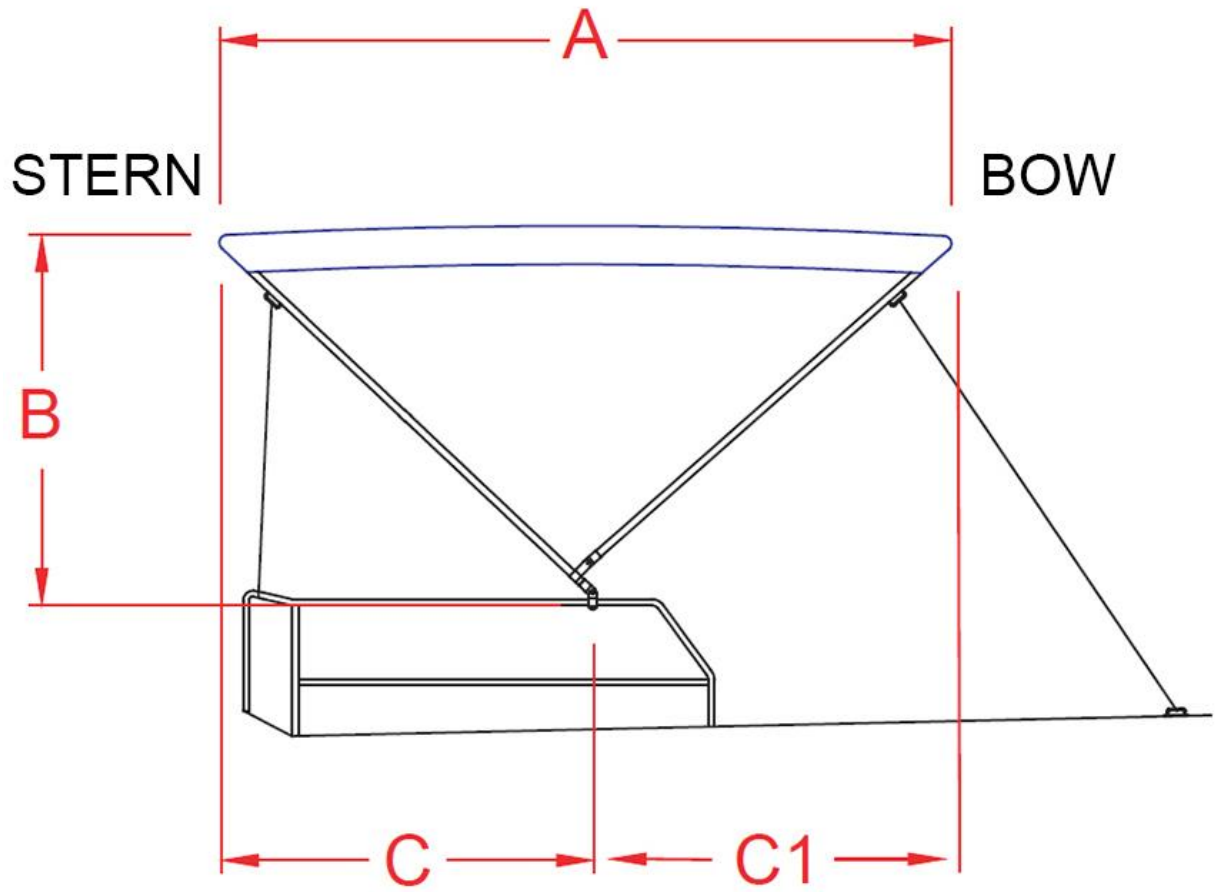

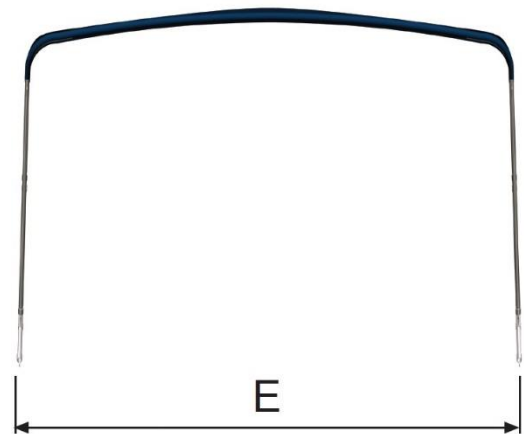
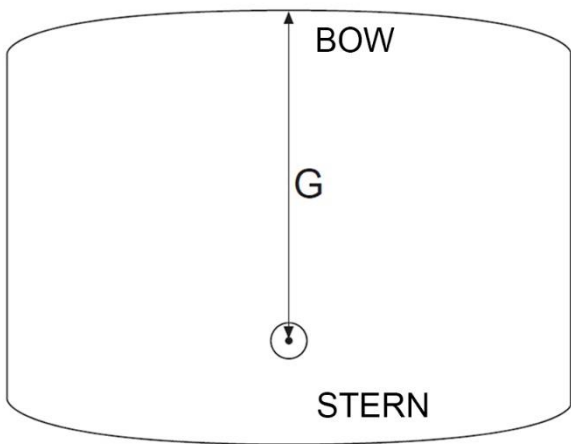
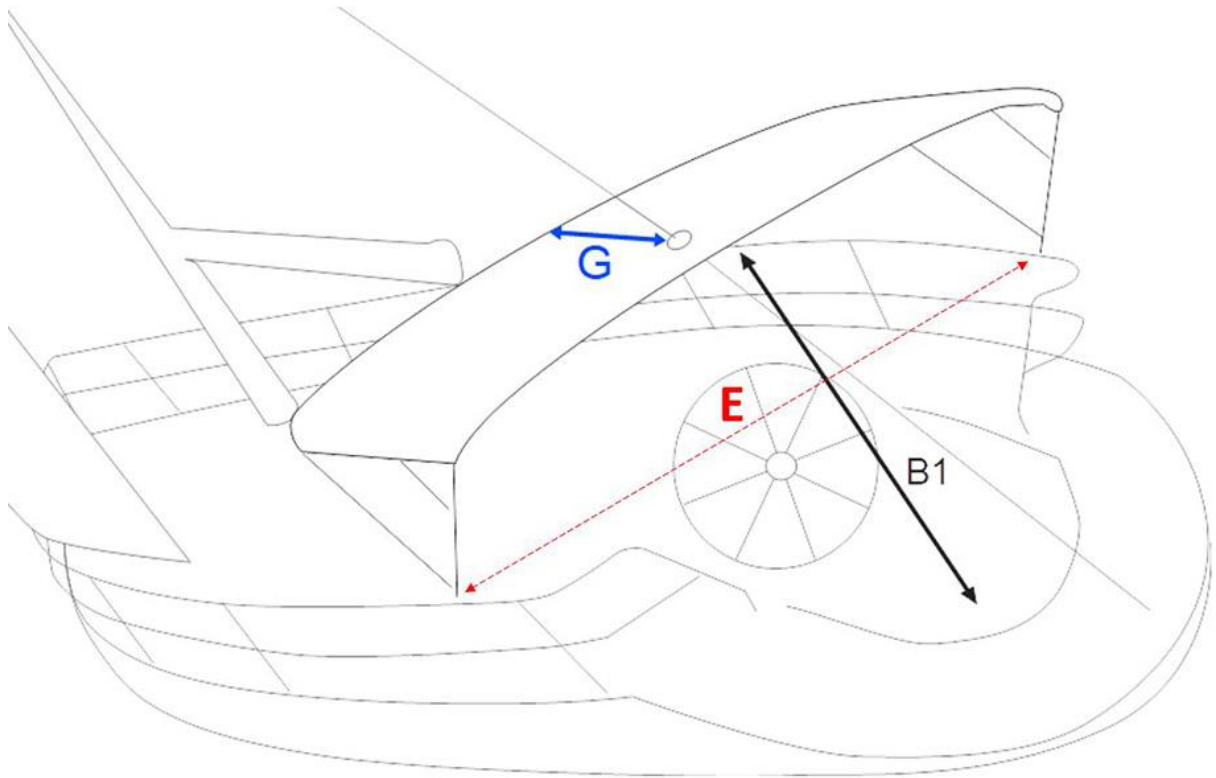

STERN

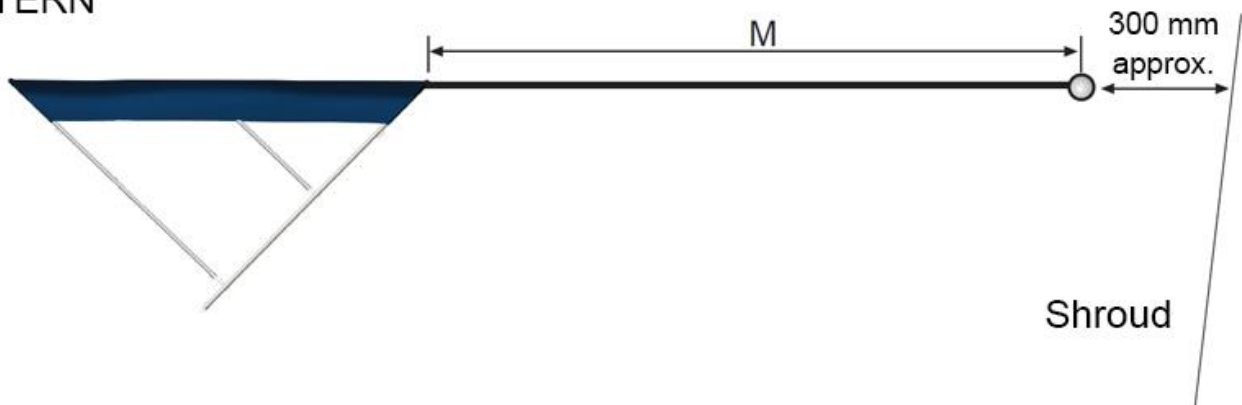

BOW

Mast

Shroud